



Gaelic Athletic Association

**OFFICIAL GUIDE
2001**

**Playing Rules:
Hurling and Football**

2

Croke Park, Dublin 3

Gaelic Athletic Association - Official Guide 2001 - Playing Rules: Hurling and Football

2

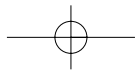

Gaelic Athletic Association
(Established 1884)



OFFICIAL GUIDE - PART - 2

*Containing Playing Rules of Hurling and
Football, revised and corrected up to date, and
published by authority of the Central Council*

ALL RIGHTS RESERVED

© Published by the Central Council of the Association,
Croke Park, Dublin, 2001

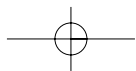

Contents

	Page
Rules of Specification	5
Rules of Control	13
The Playing Rules of Hurling	23
The Play	25
Set Play	27
Scores	32
Technical Fouls	33
Aggressive Fouls	39
Dissent	44
The Playing Rules of Football	45
The Play	47
Set Play	50
Scores	55
Technical Fouls	57
Aggressive Fouls	63
Dissent	68
Important Terms and Definitions	69
Index	73

The Field of Play For Hurling and Gaelic Football

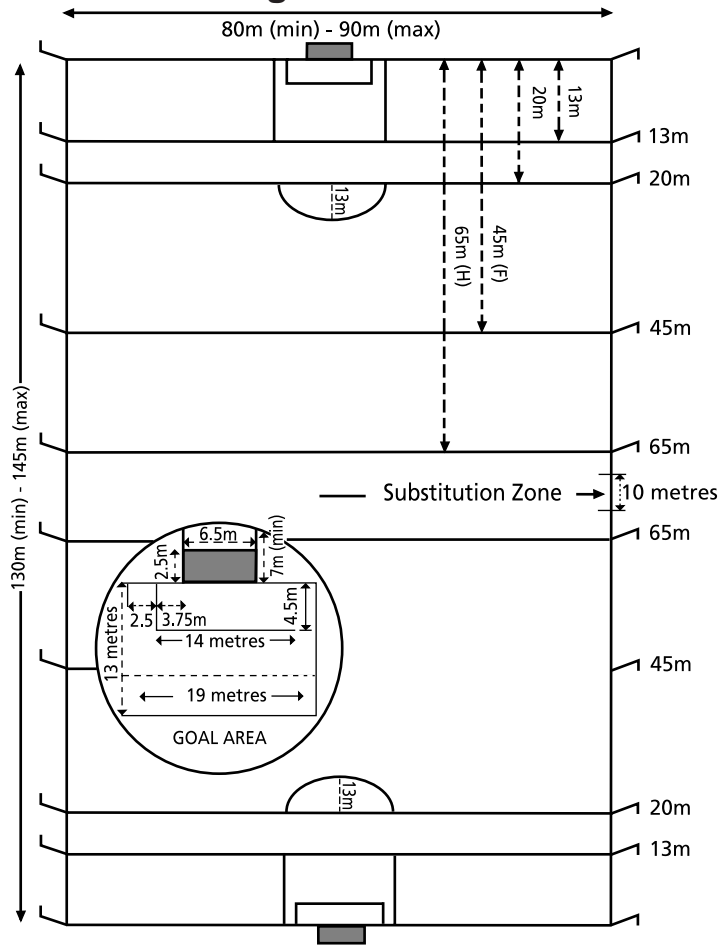

Rules of Specification

RULE 1 - THE FIELD OF PLAY

- 1.1 The field of play shall be rectangular, and its dimensions shall be as follows:
Length - 130m minimum and 145m maximum.
Width - 80m minimum and 90m maximum.

EXCEPTION

The dimensions may be reduced by local bye-laws for Under 15 or younger grades.

- 1.2 (i) At distances of 13m, 20m, 45m (Football), and 65m (Hurling) from each endline, lines shall be marked across the field parallel to the endline. The intersections of these lines and of the endlines with the sidelines shall be marked by flags.

The midline of the field shall be marked parallel to the endlines, and shall have a minimum length of 10m.

Boundary lines are part of the field of play.

- (ii) All lines on the field of play will be 90 mm \pm 13mm wide.
All lines shall be marked in white with a suitable marking material.

- 1.3 (i) THE SCORING SPACE shall be at the centre of each endline. Each shall be formed by two goalposts, circular in cross section, which shall

have a height of not less than 7m above ground level, and be 6.5m apart. The inside edge of the endline shall be at a tangent to the front edge of the base of the goalposts (See diagram).

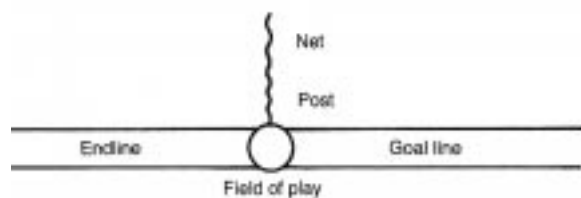

- (ii) A CROSSBAR shall be fixed to the goalposts at a uniform height of 2.5m above the ground. The crossbar shall have a rectangular or circular cross section. When rectangular, it shall have a depth of 140mm ± 10mm and a width not less than 50mm. When circular, it shall have a uniform diameter of 125mm ± 5mm.
- (iii) GOALNETS shall be securely fixed to the back of the crossbar and the back of each goalpost. The roof of the net shall be supported for a horizontal distance of not less than 900mm, at crossbar height, by a metal net support fixed to the back of the goalposts. The mesh of the net shall have a diagonal length not exceeding 150mm for football and 50mm for hurling.

EXCEPTION

The dimensions of the **Scoring Space** may be reduced by local Bye Laws for Under 15 or younger grades.

- 1.4 TWO RECTANGLES of the following dimensions shall be formed in front of each scoring space.
 - (a) One rectangle, 14m by 4.5m, shall be formed by two lines 4.5m long and at right angles to the endline being marked 3.75m from the inside of each goalpost, and the ends of these lines being joined.
 - (b) A second rectangle, 19m by 13m, shall be formed by two lines 13m long at right angles to the endline being marked 6.25m from the inside of each goalpost, and the ends of these lines being joined.
 - (c) The endline, including the goal-line, is part of each rectangle, the other three lines enclose the area of that rectangle.
- 1.5 A semi-circular arc of 13m radius, centered on the mid-point of the 20m line, shall be marked outside of each 20m line.
- 1.6 **Substitution Zone.** An area of the sideline, extending 5m. on either side of the centre line, shall be marked as the Substitution Zone, and all the players coming off/going on to the field of play in acts of substitution/temporary replacement shall go through this point, when given permission by the referee.

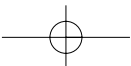

EXCEPTION

An injured player may leave the field at the nearest point to him.

- 1.7 FLAGS: All flags used on boundary lines shall have smooth rounded tops.

RULE 2 - THE PLAYERS

- 2.1 A team shall consist of fifteen players.

EXCEPTION

A County Committee may reduce the number for non-Championship games.

- 2.2 A team may commence a game with thirteen players but shall have fielded fifteen players, inclusive of players ordered off or retired injured, by the start of the second half. In the event of failure to comply with this, the game shall continue.

- 2.3 Players arriving late may join in the game during a break in play, but must report to the referee before so doing.

- 2.4 (i) A maximum of five substitutions shall be allowed. A substitution is not allowed in the case of a player ordered off.
- (ii) For extra time, a further three substitutions shall be allowed. A player ordered off, in any circumstance, during the drawn game, may not play in extra time but may be replaced.

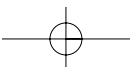
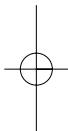

EXCEPTIONS to (i) and (ii) above

As Provided for in Rule 1.5 Blood Rule, Rules of Control.

- (iii) A substitution may only be made during a break in play, after the player has given a substitution note to the referee. This shall also apply to a temporary replacement player allowed under Rule 1.5 (Blood Rule), Rules of Control.
- (iv) In Intercounty games, all substitutions and temporary replacements must be from players on the official list submitted to the referee.

2.5 LIST OF PLAYERS

- (i) Before all official games, the referee shall be given a list of players, in duplicate and in Irish, giving full christian names. The first fifteen names appearing on a list shall be taken as constituting the actual team, unless otherwise clearly indicated.
- (ii) In Intercounty Games:
 - (a) The list of players shall be numbered from 1 to 24, and shall name the clubs to which the players belong.
 - (b) All players shall be from the list submitted to the referee prior to the game.
 - (c) For extra time, players shall be from the list submitted to the referee prior to the game.

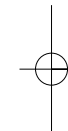

RULE 3 - TIME

- 3.1 A team shall take the field not later than ten minutes before the appointed starting time for Senior Intercounty Championships, National League Finals, Railway Cup Finals, All-Ireland, Provincial and County Senior Championships Finals, and not later than five minutes before the appointed starting time in all other games. For extra time, play shall commence not more than ten minutes after the end of the drawn game.
- 3.2 The playing time shall consist of two periods of thirty minutes each, but time shall be added on in each period for incidental or deliberate delays.
- Exceptions**
- (i) In Senior Intercounty Championship and National League games, the playing time shall consist of two periods of 35 minutes each.
 - (ii) The playing time may be reduced by local Bye-Laws for Under 15 or younger games.
- 3.3 An interval, not exceeding ten minutes, shall be allowed at half-time, following which the teams shall change ends.
- EXCEPTION**
In Senior Intercounty Championship games, the interval shall consist of a maximum of fifteen minutes.
- 3.4 If a game in a knock-out competition ends in a

draw, teams may, by consent, play extra time consisting of two periods of fifteen minutes each way, which extra time shall be obligatory in the case of a further draw in a replay.

[Note: The following exception shall apply to the Intercounty Senior Football Championship of 2001 and 2002. If a game in the Rounds up to and including Round 4 of the All-Ireland Senior Football Championship Qualifier (not including the Provincial Championships) ends in a draw, the teams shall play extra-time as prescribed above]

- 3.5 Extra time shall be obligatory in the inter-Provincial, Oireachtas, and other Intercounty Tournaments, the Sigerson and Fitzgibbon Cups, and any other games in subsidiary competitions as determined by the Central Council.
- [Note:** Up to Congress 2003, extra-time shall be played in the knock-out stages of the National Leagues, up to and including the Semi-Finals.]

RULE 4 - EQUIPMENT

- 4.1 (i) Club teams shall wear their registered distinctive colours in inter-club competitions. Where there is a similarity of colours, the teams shall change to their alternative registered colour(s), approved by the County Committee.
- (ii) County teams shall wear their registered distinctive colours in Intercounty competitions. Where there is similarity of colours, the two

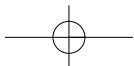

- counties shall wear their registered alternative colour(s) or other colours authorised or directed by the Committee in Charge.
- (iii) In all games, the goalkeeper shall wear a jersey which is distinctive from his own team's and the opposing team's colours.
- 4.2 A referee shall not allow a hurling helmet to be worn in a football game.
- 4.3 (i) The circumference of the hurling ball (sliotar) shall be between 23cm. and 25cm. The ball weight (mass) shall be between 110 and 120 grams. The rib shall not exceed 2.4mm. and shall not be less than 2.2mm. The thickness of the leather cover shall not be less than 1.8mm. The leather cover shall conform with the designated Irish standard. The use of laminated splits, laminated corrected grain, or laminated full grain leathers shall be excluded.
- (ii) The football shall not weigh less than 450g. and not more than 485g. and have a circumference of not less than 68cm. and not more than 70cm.
EXCEPTION - The dimensions may be reduced by local Bye-Laws for under 15 or younger grades.
 - (iii) Sliotars/Footballs shall be approved for use on the basis of compliance with standards and tests set out by Central Council.
- 4.4 The bas of a hurley at its widest point shall not be more than 13cm.

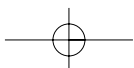
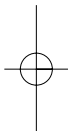

Rules of Control

RULE 1 - CONTROL OF THE GAMES:

Control of the Games shall be entrusted to a referee, four umpires and two linesmen who shall decide on the field all matters affecting play.

1.1 POWERS OF THE REFEREE

The referee's decision on any question of fact and in regard to time shall be final. The referee shall have the powers-

- (i) To appoint a replacement referee, if he is unable to act or unable to contact the Secretary of the Committee in Charge.

Otherwise, the Secretary of the Committee in Charge shall appoint a replacement referee.
- (ii) To declare the ground or other conditions unsuitable for play after consulting, where feasible, with the Officials in Charge of the fixture.
- (iii) To consult with the umpires and/or linesmen concerning infringements of the Playing Rules, in particular rough or dangerous play, striking, hitting or kicking. The referee may apply the appropriate rule following such consultations.

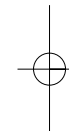

- (iv) To order a player with an injury involving bleeding to leave the field of play for medical and/or other attention
- (v) To over-rule a decision of a linesman or umpire(s).
- (vi) To award a score when the ball has been prevented from going over the goal-line or crossbar by anyone other than a player or the referee.
- (vii) To terminate a game because of outside interference, or any other serious reason that merits such action.
- (viii) To terminate a game, having first given a three minute warning to the captain or official in charge of the team or the players involved, in any of the following circumstances: -
 - (a) A player refusing to leave the field when ordered off, or having been ordered off, rejoins the game.
 - (b) A team or player(s) leaving the field either without the referee's permission, or refusing to continue playing.

1.2 **DUTIES OF THE REFEREE**

- (i) To control the game in accordance with the Playing Rules.
- (ii) To receive lists of players, sign them in Irish, and give a copy to the opposing team before the game.

- (iii) To ensure that all players are correctly and safely attired, and that all playing equipment conforms with the rules. This shall include a player coming back on to the field under the temporary replacement (blood) rule.
- (iv) To keep a record of scores, the names of players injured, replaced, substitutes taking part, temporary replacement players(s) under the Blood Rule, any instance of late fielding or of exceeding the half-time interval, and the intrusion of unauthorised persons onto the field of play.
- (v) To record playing time, and to extend time in each half for deliberate or incidental delay or to allow for a free - awarded before time had expired - to be taken. Should the defending team commit a further foul before the referee whistles for full-time, he shall further extend the time to permit an additional free to be taken, from which a score can be made, provided no other player of the side taking the free touches the ball.
- (vi) To obtain the signature, full address, and club of any player participating in the game, if requested by a captain or responsible team official.
- (vii) (a) To caution a player who commits a cautionable foul/offence, by taking his name and showing him a yellow card, which caution, unless (b) or (c) below has

- been applied, shall carry over into extra-time, where played.
- (b) To order off a player who commits a second cautionable foul/offence, by showing him a second yellow card, followed by showing him a red card.
 - (c) To order off a player who commits an ordering off foul/offence by taking his name (if not already taken) and showing him a red card.
- (viii) To report any irregularities in respect of dimensions, markings or unsatisfactory condition of the field of play, and to report any official protest made by a team captain before the game in relation to irregularities in dimensions or markings of the field of play.
 - (ix) To present the ball to the captain of the winning team at the end of a Provincial or All-Ireland Final.
 - (x) To blow the whistle when a foul has been committed or when the ball has gone out of play. To blow the whistle or give a signal to restart play. Once the referee has given a decision and has sounded his whistle to restart play, he shall not alter that decision.
 - (xi) To indicate the place from which all free kicks or free pucks shall be taken.

1.3 COMMENCING PLAY

- (i) The referee shall toss a coin for choice of ends in the presence of the team captains. This procedure shall be repeated for extra time, where played.
- (ii) Two players from each team shall stand one behind the other on their own defensive side of the halfway line, and shall face the referee, for the throw in.

The other players, shall be in their respective positions behind the 45m line (Football) or 65m line (Hurling).
- (iii) The referee, facing the players, shall throw in the ball over the heads of the players (Football) and along the ground between the players (Hurling).
- (iv) Regulations (ii) and (iii) above shall also apply for the start of the second half.

1.4 INJURIES AND INCURSIONS

The referee may give his permission to a team medical officer or one authorised official to enter the field of play to examine an injured player. No other team official shall enter the field of play. Play shall not be stopped for injury to a player, except in exceptional circumstances to enable a seriously injured player to be treated on the field or removed from the field of play. All other injuries shall be treated off the field of play.

1.5 BLOOD RULE

- (i) A player who is bleeding or has blood on any

part of his body, playing attire or playing equipment, as a result of an injury sustained during play, shall, on the instruction of the referee, immediately leave the field of play to receive medical and/or other attention. He shall not be allowed to return to the field of play until the bleeding has stopped, all blood has been cleaned off, and where possible the injured area has been covered, any bloodstained playing attire has been replaced, and any bloodstained playing equipment has been fully cleaned.

While he is receiving medical and/or other attention, the injured player may be temporarily replaced, subject to his team using a maximum of twenty players either in ordinary time, **or** in extra time, where played.

(Note: Rule 2.4 (ii), Rules of Specification, allows only three ordinary substitutions **in extra time**. The provision for a maximum of twenty players being used in extra time is to make allowance for temporary replacements under this Blood Rule).

Such a temporary replacement shall not count as one of the substitutions allowed under Rule 2.4 (i) and (ii), Rules of Specification, provided that the injured player returns to the field of play as a direct replacement for the player who temporarily replaced him.

EXCEPTIONS

- (i) If a team has used its full quota of substitutes allowed under Rule 2.4 (i) or (ii), and the Referee subsequently instructs a player of that team to leave the field of play for attention under this Blood Rule, a temporary replacement shall be allowed, and if the injured player is subsequently found to be unfit to return to the field of play or time does not permit his return, it shall not count within the quota of substitutes allowed under Rule 2.4 (i) or (ii).
- (ii) In the event of a temporary replacement player under the Blood Rule being sent off, his team shall substitute another player if they wish to bring the original player back on to the field, and this shall not count within the quota of substitutes allowed under Rule 2.4 (i) or (ii).
- (iii) If a team has used its full quota of substitutes under Rule 2.4 (i) or (ii), and the Referee subsequently instructs the goalkeeper of that team to leave the field of play for attention under this Blood Rule, a temporary replacement player may be drawn from outside the 20 players already used (either in ordinary time **or** in extra time, where played), but this temporary replacement must play as a goalkeeper and may not be used as an outfield player.

1.6 REPORT OF REFEREE

The Referee shall normally submit his report, together with a copy of each team list, within a period of three days of the game, to the Committee or Council in Charge. When the Committee in Charge deems it necessary, the report shall be submitted within 24 hours.

The report shall contain:-

- The result of the game.
- The names of the umpires and linesmen.
- The time each team took the field.
- The time the game started.
- If the interval was exceeded, a statement of the reason.
- The names of players injured, replaced, and substitutes taking part.
- The name(s) of temporary replacement player(s) under the Blood Rule.
- The names of players cautioned or ordered off, and the exact reason(s).
- The name of any official or spectator who interfered during the course of the game.
- Any other breaches of the regulations.

RULE 2 - UMPIRES

There shall be two goal umpires at each end of the field of play. An umpire shall stand behind each goalpost and behind the endline. The umpires shall remain at the same end for the duration of the game.

2.1 POWERS OF UMPIRES

- (i) The umpires shall decide if a score is made, or

if the ball has crossed the endline for a wide, or for a 45m or 65m free, subject to Rule 1.1(v) above.

- (ii) The umpires shall have the power to bring to the notice of the referee, during a break in play, any instances of foul play, or incursions onto the field of play, which have not been noticed by the referee.

2.2 DUTIES OF UMPIRES

The umpires shall signal their decisions as follows:

- (a) A 45m free in Football or a 65m free in Hurling by raising an arm upright, and then pointing directly infield, at the place where the ball passed over the endline.
- (b) A wide by crossing both arms above the head.
- (c) A score by raising a green flag for a goal or a white flag for a point, in front of the scoring space.
- (d) A decision to disallow a score by crossing the flags at the centre of the scoring space.

RULE 3 - LINESMEN

There shall be one linesman on each sideline. Linesmen shall change sides at half-time. However, failure to do so will not affect the result of the game.

3.1 POWERS OF LINESMEN

The linesmen shall have the power to bring to the attention of the referee, during a break in play, any instances of foul play, or incursions onto the field of play which have not been noticed by the referee.

3.2 DUTIES OF THE LINESMEN

- (i) The linesmen shall indicate by flag signal:
 - (a) when and where a ball crosses the sideline.
 - (b) which side is entitled to the sideline kick or puck, and
 - (c) where the kick or puck is to be taken from.
- (ii) Where a ball is played across a sideline by opposing players simultaneously, or when the linesman is unsure which team played the ball over the sideline, the linesman, facing the players, shall throw in the ball.
- (iii) A linesman's decision is subject to Rule 1.1 (v) above.
- (iv) The linesmen, where neutral, shall control the operation of the Substitution Zone, and shall assist the referee in regard to the introduction of substitutes, and of temporary replacement players under the Blood Rule. Where linesmen are not neutral, these functions shall be controlled by the referee.



The Playing Rules of Hurling

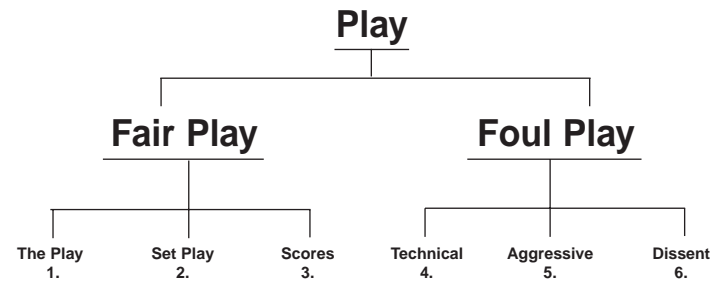

Line Out

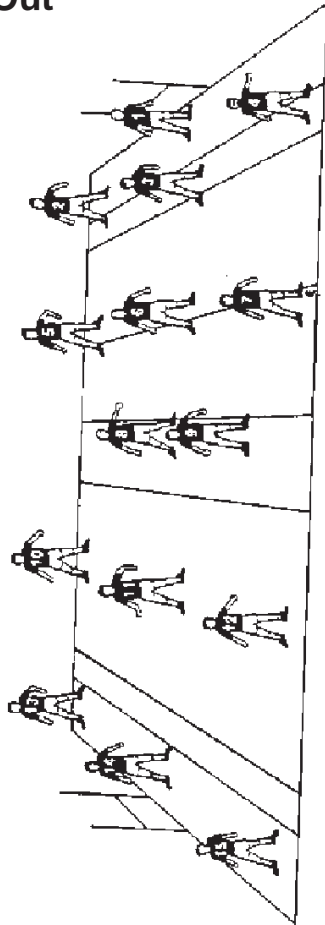

24

The Rules of Hurling

Rules of Fair Play

RULE 1 - THE PLAY

- 1.1 The ball is in play once it has been thrown in or pucked, after the referee has given a signal to start or restart play, and it remains in play until:
 - (a) the referee signals a stop;
 - (b) the ball has passed completely over any boundary line or strikes any flag marking the boundary lines;
 - (c) the ball has been prevented from going over any boundary line or is touched in play by anyone other than a player.
- 1.2 The ball may be struck with the hurley when it is on the ground, in the air, tossed from the hand or lifted with the hurley.
- 1.3 A player may run with the ball balanced on or hopping on his hurley.
- 1.4 A player may catch the ball, play it on his hurley, and bring it back into his hand once. A player who has not caught the ball may play it from the hurley into his hand twice.
- 1.5 The ball may be struck with the hand, kicked, or lifted off the ground with the feet.

25

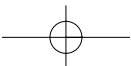

- 1.6 The ball may not be touched on the ground with the hand(s), except when a player is knocked down or falls and the ball in his hand touches the ground.
- 1.7 The ball may be carried in the hand for a maximum of four consecutive steps or held in the hand for no longer than the time needed to take four steps.
- 1.8 Player(s) may tackle an opponent for the ball.
- 1.9 Provided that he has at least one foot on the ground, a player may make a side-to-side charge on an opponent-
 - (a) who is in possession of the ball, or
 - (b) who is playing the ball, or
 - (c) when both players are moving in the direction of the ball to play it.

When he is within the small rectangle, the goalkeeper may not be charged but he may be challenged for possession of the ball, and his puck, kick or pass may be blocked. Incidental contact with the goalkeeper while playing the ball is permitted.
- 1.10 For a run-up to a free puck, side-line puck, or puck-out, a player may go outside the boundary lines, but otherwise players shall remain within the field of play.
- 1.11 A player may hold up his hurley or hand(s) to intercept a free puck.

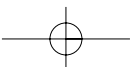
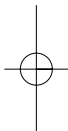

RULE 2 - SET PLAY

- 2.1 The referee, facing the players, starts the game and re-starts it after half-time by throwing in the ball between two players from each team, who shall stand one behind the other in their own defensive sides of the half-way line. All other players shall be in their respective positions behind the 65m lines.
- 2.2 After a foul, play is restarted by a free puck or a throw-in where the foul(s) occurred.

EXCEPTIONS

- (i) In the case of fouls by defending players within the rectangles, the following shall apply:
 A penalty puck shall be awarded for an Aggressive Foul within the large rectangle. The penalty puck shall be taken from the centre point of the 20m line. A free puck from the centre of the 20m line shall be awarded for a Technical Foul within the large rectangle.
- (ii) A free puck, awarded for a foul by a defending player inside his own 20m line but outside the large rectangle, shall be taken from the 20m line opposite where the foul occurred.
- (iii) When a player is fouled immediately after he plays the ball away, and a score results, it shall stand. Otherwise, the referee shall award a free-puck from where the foul occurred or, if more advantageous, from where the ball lands or crosses the side-line.

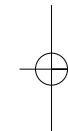

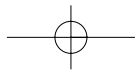

- With the option of a free being awarded from where the foul occurred being retained, the rule shall apply in the following circumstances as outlined:-
- (a) If the ball lands over the end-line, a free shall be given on the 20m line opposite the place where the ball crossed the end-line.
 - (b) If the ball lands inside the opponents' 20m line, a free shall be given from the 20m line opposite the place where the ball crossed this line.
 - (iv) Where otherwise specified in the penalties listed in Rule 4, Sections 14, 15, 16, 17, 18, 19, 27, 28, 29, 30 and Rule 6.2
 - (v) When play is re-started by throwing in the ball after a foul(s) between the end-line and the 20m line, the throw-in shall be given on the 20m line, opposite where the foul(s) occurred.

All players, except the player taking the free puck (excluding penalties), shall be 20m from where the free puck is being taken or all players, except those two contesting the throw-in, shall be 13m from where the throw-in, is awarded.

- 2.3 A penalty puck shall be taken at the centre point of the 20m line and the semi-circular arc, and only three defending players may stand on the goal-line. All other players, with the exception of the player taking the puck, shall be outside the 20m line, and shall not cross the

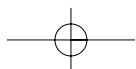

20m line or the arc until the ball has been struck. If a defending player(s) fouls before the ball is struck and a goal does not result, the referee shall allow the penalty puck to be retaken.

- 2.4 When opposing players foul simultaneously, play is restarted by throwing in the ball.
- 2.5 For all free pucks, including penalties, the ball may be struck with the hurley in either of two ways:
- (a) Lift the ball with the hurley at the first attempt and strike it with the hurley.
 - (b) Strike the ball on the ground.
- If a player taking a free puck or penalty fails to lift the ball at the first attempt, or fails to strike it with the hurley, he must strike it on the ground without delay. Only when he delays, may a player of either side approach nearer than 20m. except in the case of penalties.
- 2.6 When the ball is played over the end-line by the team attacking that end or after a score, play is restarted by a puck-out from within the small rectangle.

The player taking a puck-out shall take the ball into his hand, but should he miss his stroke, the ball may be struck on the ground or may be raised with and struck with the hurley, but not taken into his hand again before striking it. The player taking the puck-out may strike the ball more than once before another player touches it.

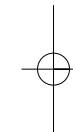

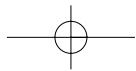

All players shall be outside the 20m line until the ball has been struck except the goalkeeper and the player taking the puck-out - if other than the goalkeeper.

The ball shall travel 13m before being played by another player of the defending team.

2.7 When the ball is played over the end-line and outside the goal-posts by the team defending that end, a free puck shall be awarded to the opposing team on the 65m line opposite where the ball crossed the end-line.

2.8 When a team plays the ball over the side-line, a free puck from the ground shall be awarded to the opposing team at the place where the ball crossed the side-line. If opposing players play the ball simultaneously over the side-line, or if the officials are not sure which team played the ball last, the linesman shall throw in the ball between one player from each team. A ball that strikes a side-line or corner flag shall be treated as having crossed the side-line. A player on the team awarded a side-line puck shall place the ball on the side-line at the place indicated by the linesman. All players except the player taking the side-line puck, or the two players contesting the throw-in, shall be at least 13m from the ball until it is struck or thrown in.

If a player taking a side-line puck fails to strike the ball at the first attempt, he shall not delay in making a second attempt. Only when the player delays his second attempt to strike the

ball may a player from either side approach nearer than 13m.

2.9 If the ball touches any non-player during play, play is restarted by throwing in the ball at the place concerned, but if the ball touches any non-player from a free puck, the free shall be retaken.

EXCEPTIONS

- (i) As provided in Rule 3.3(a).
- (ii) If the ball has been prevented from going over a boundary line by a non-player other than the referee, it shall be treated as having crossed the line, and the referee shall make the appropriate award.

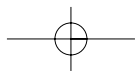

RULE 3 - SCORES

- 3.1 A **goal** is scored when the ball is played over the goal line between the posts and under the crossbar by either team.
 A **point** is scored when the ball is played over the crossbar between the posts by either team.
 A goal is equivalent to three points.
 The team with the greater final total of points is the winner.

EXCEPTIONS

- A player on the team attacking a goal who is in possession of the ball may not score;
- (i) by carrying the ball over his opponents' goal-line, or
 - (ii) with his hand(s)
- 3.2 A score may be made by striking the ball in flight with the hand(s).
- 3.3 (a) A score shall be allowed if, in the opinion of the referee, the ball was prevented from crossing the goal-line by anyone other than a player or the referee.
- (b) If part of the goal-posts or crossbar is displaced during play, the referee shall award the score which he considers would have resulted had a part not been displaced.
- 3.4 If a defending player plays the ball through his own scoring space in any manner, this shall count as a score.

Rules of Foul Play

RULE 4 - TECHNICAL FOULS

- 4.1 To overcarry or overhold the ball.
- 4.2 To throw the ball.
- 4.3 To lift the ball off the ground with the knees.
- 4.4 To lie on the ball.
- 4.5 To touch the ball on the ground with the hand(s), except when a player falls or is knocked down and the ball in his hand touches the ground.
- 4.6 To catch the ball more than twice before playing it away.
- 4.7 To toss the ball with the hand and catch it without playing it with the hurley.
- 4.8 To drop the hurley intentionally, or to throw the hurley in a manner which does not constitute a danger to another player.
- 4.9 To tip an opponent's hurley in the air or to tip it up with hurley or foot, for the purpose of allowing the ball to pass through.
- 4.10 For an attacking player to enter opponents' small rectangle before the ball enters it during the play.

EXCEPTIONS

- (i) If an attacking player legally enters the small rectangle, and the ball is played from that area but is returned before the attacking player has time to leave the area, provided that he does not play the ball or interfere with the defence, a foul is not committed.

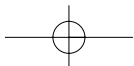

- (ii) When a point is scored from outside the small rectangle and the ball is sufficiently high to be out of reach of all players, the score shall be allowed even though an attacking player may have been within the small rectangle before the ball - provided that the player in question does not interfere with the defence.
- 4.11 (a) For a player on the team awarded a free puck to stand or move nearer than 20m to the ball before it is struck.
- (b) For a player on the team awarded a side-line puck to stand or move nearer than 13m to the ball before it is struck.
- (c) For a player on the team awarded a penalty puck to be inside the 20m line or the arc before the ball is struck.
- 4.12 For a player attacking a goal to carry the ball over opponents' goal-line.
- 4.13 For a player on the team attacking a goal, who is in possession of the ball, to score with the hand(s).
PENALTY FOR ABOVE FOULS - Free puck from where the foul occurred, except as provided under EXCEPTIONS of Rule 2.2.
- 4.14 To be inside opponents' 20m line before a puck-out is taken after a wide.
PENALTY - Free puck from the defenders' 20m line opposite where the foul occurred.

- 4.15 To take the puck-out from outside the small rectangle.
PENALTY - 65m free opposite where the foul occurred.
- 4.16 (a) For a player on the team defending a penalty puck, with the exception of the three defending players on the goal-line, to be inside the 20m line or the semi-circle before the puck is taken.
- (b) For any of the three players defending a penalty on the goal-line to move nearer than 20m to the ball before the penalty puck is taken.
PENALTY - If a goal is not scored, the referee shall allow the penalty puck to be retaken.
- 4.17 (a) For an opposing player to be nearer than 20m to the ball before a free puck is struck.
- (b) For an opposing player to be nearer than 13m to the ball before a side-line puck is struck.
PENALTY FOR THE ABOVE FOULS - Free puck 13m more advantageous than the place of original puck - up to opponents' 20m line.
- 4.18 To delay an opponent taking a free puck or side-line puck by hitting or kicking the ball away, not releasing the ball to the opposition, or by deliberately not moving back to allow the puck to be taken.
- 4.19 To interfere with a player taking a free puck or side-line puck by jumping up and down,

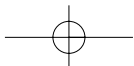

waving hands or hurley, or any other physical or verbal interference considered by the referee to be aimed at distracting the player taking the puck.

EXCEPTION

A player holding his hands or hurley upright shall not constitute an interference.

PENALTY - Free puck 13m more advantageous than the place of original puck - up to opponents' 20m line.

- 4.20 To reset the ball for a free/penalty/sideline puck without the referee's permission after the whistle has been blown for the free/penalty/sideline puck to be taken.
- 4.21 To play the ball again after taking a free/penalty/sideline puck before another player has played it, unless the ball rebounds off the goal-posts or crossbar.
- 4.22 To foul a free puck by making a second attempt to lift the ball, to hop the ball on the hurley, or to take the ball in the hand.
- 4.23 For the player taking a side-line puck to attempt to lift the ball with his hurley.
- 4.24 To make a divot for the purpose of teeing up the ball for a free puck or side-line puck.
- 4.25 To advance the ball deliberately from the place at which a free puck or side-line puck is to be taken.

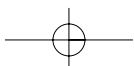

- 4.26 To waste time by delaying a free puck or side-line puck awarded to own team.

PENALTY FOR THE ABOVE FOULS -

- (i) Cancel free puck or side-line puck.**
- (ii) Throw in the ball where the foul occurred, except as provided under EXCEPTION (v) of Rule 2.2.**

- 4.27 For the player taking the puck-out and, having missed a stroke, to take the ball into his hand a second time before striking.
 - 4.28 To be inside own 20m line when one's team is taking a puck-out except as provided in Rule 2.6.
 - 4.29 For another player on the team taking the puck-out to play the ball before it has travelled 13m.
 - 4.30 To waste time by delaying own puck-out.
- PENALTY FOR ABOVE FOULS -**
- (i) Cancel puck-out.**
 - (ii) Throw in the ball on defenders' 20m line opposite the scoring space.**
- 4.31 For a player(s) from each team to foul simultaneously.
- PENALTY - Throw in the ball where the foul(s) occurred, except as provided under EXCEPTION (v) of Rule 2.2.**
- 4.32 To go outside the boundary lines to gain an advantage except as permitted by Rule 1.10.

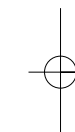

4.33 To interfere with the goal-posts to distract opponents or to gain an advantage.

**PENALTY FOR THE ABOVE FOULS -
Caution offender; order off for second cautionable offence.**

4.34 When a team commits a Technical Foul, the referee may allow the play to continue if he considers it to be to the advantage of the opposing team. Once he allows play to continue, he may not subsequently award a free for that foul. He shall apply any relevant disciplinary action.

RULE 5 - AGGRESSIVE FOULS

- 5.1 To strike or attempt to strike an opponent with a hurley, head, arm, elbow, hand or knee.
- 5.2 To kick or attempt to kick an opponent.
- 5.3 To stamp on an opponent.
- 5.4 To behave in any way which is dangerous to an opponent.
- 5.5 To strike, attempt to strike, to interfere with, to threaten, or to use abusive language or conduct to a match official.

PENALTY FOR THE ABOVE FOULS -

- (1) Order offender off.**
- (ii) Free puck from where foul occurred, except as provided under EXCEPTIONS of Rule 2.2.**

- 5.6 To commit any of the fouls listed in Rule 5.1 to Rule 5.4 inclusive against a team-mate.

PENALTY -

- (i) Order offender off.**
- (ii) Throw in the ball where the foul occurred, except as provided under EXCEPTION (v) of Rule 2.2**

- 5.7 To commit any of the fouls listed in Rule 5.1 to Rule 5.4 inclusive on an opponent, on the field, prior to the start of the game or at half-time.

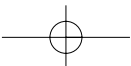

PENALTY - Offender shall be treated as ordered off and shall not participate (or further participate) in the game.

NOTE: Once the referee has received the list of players, or a substitution/temporary replacement slip which includes the offender's name, the player may not be substituted.

- 5.8 To pull down an opponent
- 5.9 To trip an opponent with hand(s), foot, or hurley.
- 5.10 To jump at an opponent.
- 5.11 To threaten or to use abusive or provocative language or gestures to an opponent.
- 5.12 To engage in any form of rough play.
- 5.13 To make 'a pull' with the hurley from behind and around the body of an opponent that is not consistent with an attempt to play the ball.
- 5.14 To use the hurley in a careless manner.
- 5.15 To throw a hurley in a manner which constitutes a danger to another player(s).
- 5.16 To 'pull' with the hurley before the ball arrives.

PENALTY FOR ABOVE FOULS -

- (1) Caution offender; order off for second cautionable foul.**
- (ii) Free puck from where the foul occurred except as provided under EXCEPTIONS of Rule 2.2.**

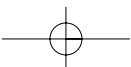

- 5.17 To threaten or to use abusive or provocative language or gestures to a team-mate.

PENALTY FOR ABOVE FOULS -

- (i) Caution offender; order off for second cautionable foul.**
 - (ii) Throw in the ball where the foul occurred, except as provided under EXCEPTION (v) of Rule 2.2.**
- 5.18 (a) To push an opponent or hold an opponent with the hand(s) or hurley.
 - (b) To hold opponent's hurley or pull it from his hand(s).
 - 5.19 (a) To charge an opponent in the back or to the front.
 - (b) To charge an opponent unless:-
 - (i) he is in possession of the ball, or
 - (ii) he is playing the ball, or
 - (iii) both players are moving in the direction of the ball to play it.
 - (c) To charge an opponent for the purpose of giving an advantage to a team-mate.
 - (d) To charge the goalkeeper in his small rectangle.
 - (e) For a player in possession of the ball to charge an opponent.
 - 5.20 To use the hurley to obstruct an opponent.

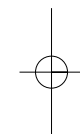

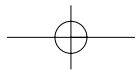

- 5.21 To strike an opponent's hurley unless both players are in the act of striking the ball.
- PENALTY FOR THE ABOVE FOULS -**
- (i) **Free puck from where foul occurred, except as provided under Exceptions of Rule 2.2**
 - (ii) **Caution offender for committing any of the above fouls a second time; order off for a further repetition or for other cautionable foul.**

5.22 For a player to retaliate between the award of a free to his team and the free puck being taken.

PENALTY -

- (i) **Cancel free puck.**
- (ii) **Throw in the ball where the original foul occurred, except as provided under EXCEPTION (v) of Rule 2.2.**
- (iii) **Apply any other relevant penalty of Rule 5.**

5.23 For a player(s) from each team to foul simultaneously.

PENALTY -

- (i) **Throw in the ball where the fouls occurred, except as provided under EXCEPTION (v) of Rule 2.2**
- (ii) **Apply any other relevant penalty of Rule 5.**

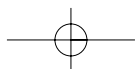

- 5.24 When an Aggressive Foul is drawn to the referee's attention by an umpire or linesman, the referee may apply the appropriate penalty as per Rule 5, and shall restart play as per Rule 2.
- 5.25 When a team commits an Aggressive Foul, the referee may allow play to continue if he considers it to be to the advantage of the offended team. Once the referee allows the play to continue, he may not subsequently award a free for that foul. He shall apply the relevant penalty.

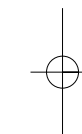

RULE 6 - DISSENT

6.1 To challenge the authority of a match official.

PENALTY - Caution the offender; order off for second cautionable foul.

6.2 To show dissent with the referee's decision to award a free puck to the opposing team.

PENALTY - The free puck already awarded shall be taken 13m more advantageous than the place of original free puck, up to the opponents' 20m line.

6.3 (a) To refuse to leave the field of play when ordered off.

(b) To rejoin the game after being ordered off.

PROCEDURE

First give a three minute warning to the team captain or the official in charge of the team, or the player(s) involved, and then, if the player(s) refuse(s) to comply, terminate the game.

6.4 A team or a player(s) leaving the field without the referee's permission or refusing to continue playing.

PROCEDURE - as in Rule 6.3

Any player willing to continue shall give his name to the referee.



The Playing Rules of Gaelic Football

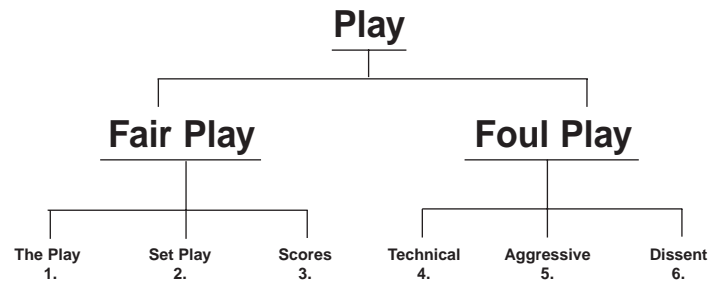

Line Out

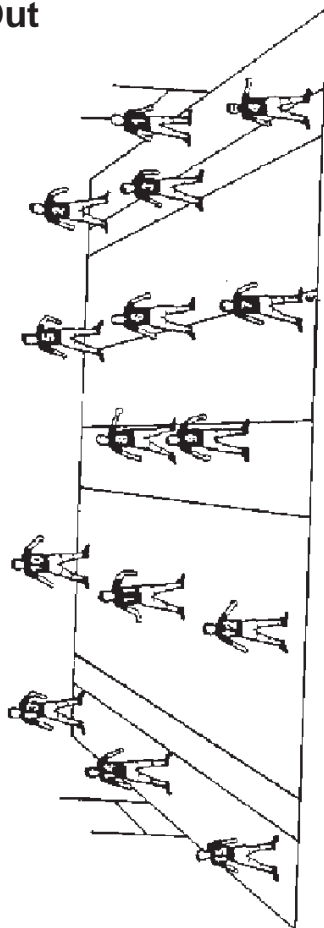

The Rules of Football Rules of Fair Play

RULE 1 - THE PLAY

- 1.1 The ball is in play once it has been thrown in or kicked after the referee has given a signal to start or restart play, and it remains in play until:
- (a) the referee signals a stop;
 - (b) the ball has passed completely over any boundary line or strikes any flag marking the boundary lines;
 - (c) the ball has been prevented from going over any boundary line or is touched in play by anyone other than a player.
- 1.2 When the ball is on the ground, it may be played by any part of the body except the hand(s). It may be lifted off the ground with the feet.

EXCEPTIONS

- (i) The goalkeeper may play the ball on the ground with his hand(s) inside his own small rectangle.
- (ii) Any player who falls or is knocked to the ground while in possession of the ball may fist or palm the ball away on the ground, and may score by so doing.
- (iii) The ball may not be lifted off the ground with the knees.

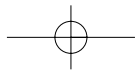

- 1.3 When the ball is not on the ground, it may be played by any part of the body.
- 1.4 When a player is in possession of the ball, it may be:-
- (a) carried for a maximum of four consecutive steps or held in the hand(s) for no longer than the time needed to take four steps;
 - (b) played from the foot to the hand(s) -toe-tapped;
 - (c) bounced once, and once after each toe-tap;
 - (d) changed from one hand to the other once, with the original holding hand maintaining contact until the change is completed;
 - (e) struck with the open hand(s) or fist, provided there is a definite striking action;
 - (f) tossed for a kick, a toe-tap or a pass with the hand(s).
- The ball may be knocked from an opponent's hand(s) by flicking it with the open hand.
- 1.5 When the ball has not been caught, it may be bounced more than once in succession.
- 1.6 Player(s) may tackle an opponent for the ball.
- 1.7 Provided he has at least one foot on the ground, a player may make a side-to-side charge on an opponent:-
- (a) who is in possession of the ball, or
 - (b) who is playing the ball, or
 - (c) when both players are moving in the direction of the ball to play it.

When he is within the small rectangle, the goalkeeper may not be charged but he may be challenged for possession of the ball, and his kick or pass may be blocked. Incidental contact with the goalkeeper while playing the ball is permitted.

- 1.8 A goalkeeper may move along his goal-line when a penalty kick is being taken.
- 1.9 For a run-up to a free kick, side-line kick or kick-out, a player may go outside a boundary line, otherwise players shall remain within the field of play.
- 1.10 A player may hold up his hands to intercept a free kick.

RULE 2 - SET PLAY

- 2.1 The referee, facing the players, starts the game and restarts it after half-time, by throwing in the ball between two players from each team, who shall stand one behind the other in their own defensive sides of the half-way line. All other players shall be in their respective positions behind the 45m lines.
- 2.2 After a foul, play is restarted by a free kick or a throw-in where the foul(s) occurred.

EXCEPTIONS

- (i) In the case of fouls by a defending player within the rectangles, the following shall apply;
- A penalty kick shall be awarded for an Aggressive Foul within the large rectangle or any foul within the small rectangle. The penalty kick shall be taken from the ground at the centre point of the 13m line. A free kick from the centre of the 13m line shall be awarded for a Technical Foul by a defending player within the large rectangle but outside the small rectangle.
- (ii) A free kick awarded for a foul by a defending player inside his own 13m line but outside the large rectangle shall be taken from the 13m line opposite where the foul occurred.

- (iii) When a player is fouled immediately after he plays the ball away and a score results, it shall stand. Otherwise, the referee shall award a free kick from where the foul occurred or, if more advantageous, from where the ball lands or crosses the sideline. With the option of a free being awarded from where the foul occurred being retained, the rule shall apply in the following circumstances as outlined:-
- (a) If the ball lands over the end-line, the free kick shall be given on the 13m line opposite the place where the ball crossed the end-line,
- (b) if the ball lands inside the opponents' 13m line, a free kick shall be given from the 13m opposite the place where the ball crossed this line.
- (iv) Where otherwise specified in the penalties listed in Rule 4 Sections 14, 15, 16, 17, 18, 19, 20, 26, 27, 28, 29, 30, 31, 32, and Rule 6.2.
- (v) When play is restarted by throwing in the ball after a foul(s) between the end-line and the 20m line, the throw-in shall be given on the 20m line opposite where the foul(s) occurred.
- All players except the player taking the free kick shall be at least 13m from where the free kick is awarded, or, all players

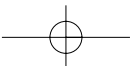

except those two contesting the throw-in shall be at least 13m from where the throw-in is awarded.

- 2.3 A penalty kick shall be taken from the ground at the centre point of the 13m line, and only the defending goalkeeper may stand on the goal-line. All other players, with the exception of the player taking the kick, shall be outside the 20m line and the arc, be at least 13m from the ball, and shall not cross the 20m line or the arc until the ball has been kicked. The goalkeeper may move along his line, but may not advance from the goal-line until the ball has been kicked. If a defending player fouls before the ball is kicked and a goal does not result, the referee shall allow the penalty kick to be retaken.
- 2.4 When opposing players foul simultaneously, play is restarted by throwing in the ball.
- 2.5 A free-kick, other than a penalty-kick, may be taken from the hands or from the ground. A player having indicated his option to the referee shall not be permitted to change his decision. The ball shall be stationary when a free kick is taken from the ground.
- 2.6 With the referee's consent, a free kick may be taken immediately.

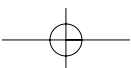

EXCEPTIONS

A penalty kick and a free kick awarded to a team from their opponents' 13m line.

- 2.7 (a) When the ball is played over the end-line by the team attacking that end, play is restarted by a kick-out off the ground from within the small rectangle. The player taking a kick-out may kick the ball more than once before any other player touches it, but may not take the ball into his hand(s). If the goalkeeper is not taking the kick-out, he shall stay in the small rectangle, and all other players except the player taking the kick-out shall be outside the 20m line until the ball has been kicked. The ball shall travel 13m before being played by another player of the defending team.
- (b) After a score, the kick-out shall be taken from the ground on the 20m line in front of the scoring space. All players, except the goalkeeper and the player taking the kick-out (if other than the goalkeeper), shall be outside the 20m line. All other players shall be 13m from the ball until it has been kicked.
- 2.8 When the ball is played over the end-line and outside the goalposts by the team defending that end, a free kick off the ground shall be awarded to the opposing team on the 45m line opposite where the ball crossed the end-line.

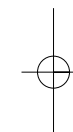

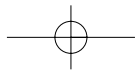

2.9 When a team plays the ball over the side-line, a free kick from the hand(s) shall be awarded to the opposing team from the place where the ball crossed the side-line. If opposing players play the ball simultaneously over the side-line, or if the officials are not sure which team played the ball last, the linesman shall throw in the ball between one player from each team. A ball that strikes a side-line or corner flag shall be treated as having crossed the side-line. All players except the player taking the side-line kick, or the two players contesting the throw-in, shall be at least 13m from the ball until it has been kicked or thrown in.

2.10 If the ball touches any non-player during play, play is restarted by throwing in the ball at the place concerned, but if the ball touches any non-player from a free kick, the free kick shall be retaken.

EXCEPTION

- (i) As provided in Rule 3.3 (a)
- (ii) If the ball has been prevented from going over a boundary line by a non-player other than the referee, it shall be treated as having crossed the line, and the referee shall make the appropriate award.

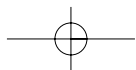
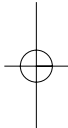

RULE 3 - SCORES

3.1 A **goal** is scored when the ball is played over the goal-line between the posts and under the crossbar by either team.

A **point** is scored when the ball is played over the crossbar between the posts by either team.

A goal is equivalent to three points.

The team with the greater final total of points is the winner.

EXCEPTIONS

A player on the team attacking a goal and who is in possession of the ball may not score: -

- (i) by carrying the ball over his opponents' goal-line;
- (ii) a goal with his hands except as provided in Rule 1.2 EXCEPTION (ii);
- (iii) a point with his open hand(s), but may score a point by fisting the ball.

3.2 A score may be made by striking the ball in flight with the hand(s).

3.3 (a) A score shall be allowed if, in the opinion of the referee, the ball was prevented from crossing the goal-line by anyone other than a player or the referee.

(b) If part of the goal-posts or crossbar is displaced during play, the referee shall award the score which he considers would have resulted had a part not been displaced.

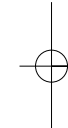

- 3.4 If a defending player plays the ball through his own scoring space in any manner, this shall count as a score.

Rules of Foul Play

RULE 4 - TECHNICAL FOULS

- 4.1 To overcarry or overhold the ball.
- 4.2 (a) To throw the ball.
(b) To handpass the ball without a definite striking action.
- 4.3 To lift the ball off the ground with the knees.
- 4.4 To lie on the ball.
- 4.5 To touch the ball on the ground with the hand(s), except as provided in Rule 1.2.
- 4.6 To bounce the ball more than once consecutively after catching it.
- 4.7 To play the ball up with the hand(s) and catch it again before it touches the ground, another player, or goal-posts.
- 4.8 To wrest the ball from an opponent who has caught the ball.
- 4.9 For an attacking player to enter opponents' small rectangle before the ball enters it during play.

EXCEPTIONS

- (i) If an attacking player legally enters the small rectangle, and the ball is played from that area but is returned before the attacking player has time to leave the

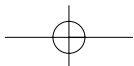

- area, provided he does not play the ball or interfere with the defence, a foul is not committed.
- (ii) When a point is scored from outside the small rectangle and the ball is sufficiently high to be out of reach of all players, the score shall be allowed even though an attacking player may have been within the small rectangle before the ball - provided that the player in question does not interfere with the defence.
- 4.10 (a) To change the ball from one hand to the other, without the original holding hand maintaining contact until the change is completed.
- (b) To change the ball from one hand to the other more than once, unless the ball is bounced or toe-tapped between the changes.
- 4.11 (a) For a player on the team awarded a free kick or a side-line kick to be less than 13m from the ball before it is kicked.
- (b) For a player on the team awarded a penalty kick to be inside the 20m line or the arc before the ball is kicked.
- 4.12 For a player attacking a goal to carry the ball over opponents' goal-line.
- 4.13 For a player attacking a goal who is in possession of the ball to score a goal with his hand(s) or a point with his open hand(s), except as provided in Rule 1.2 EXCEPTION (ii).

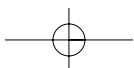

PENALTY FOR ABOVE FOULS - Free kick from where the foul occurred except as provided under EXCEPTIONS of Rule 2.2

- 4.14 To be inside opponents' 20m line before the kick-out is taken after a wide.
- PENALTY - Free kick from defenders' 20m line opposite where the foul occurred.**
- 4.15 When within own small rectangle to be less than 13m from the ball for opponents' free kick.
- PENALTY - Penalty kick.**
- 4.16 (a) For a player on the team defending a penalty kick, with the exception of the goalkeeper, to be inside the 20m line or the arc before the kick is taken.
- (b) For the goalkeeper defending a penalty kick to move nearer than 13m before the kick is taken.
- PENALTY - If a goal is not scored, the referee shall allow the penalty kick to be retaken.**
- 4.17 For an opposing player to be nearer than 13m to the ball before a free kick or a side-line kick is taken.
- PENALTY - Free kick 13m more advantageous than place of original kick - up to opponents' 13m line.**
- 4.18 To delay an opponent taking a free kick or side-line kick by hitting or kicking the ball away, not releasing the ball to the opposition, or deliberately not moving back to allow a quick free kick to be taken.

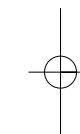

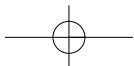

4.19 To interfere with a player taking a free kick or side-line kick by jumping up and down, waving hands, or any other physical or verbal interference considered by the referee to be aimed at distracting the player taking the kick.

EXCEPTION

A player holding his hands upright shall not constitute an interference.

PENALTY - FOR THE ABOVE FOULS - Free kick 13m more advantageous than the place of original kick - up to opponents' 13m line.

4.20 For an opposing player to be less than 13m from the ball before a kick-out after a score.

PENALTY - Free kick 13m more advantageous than place of original kick-out.

4.21 To reset the ball for a kick-out/free kick/penalty from the ground, without the referee's permission, after the whistle has been blown for the kick-out/ free kick/penalty, to be taken from the ground.

4.22 To play the ball again after taking a free kick / penalty / sideline kick before another player has touched it, unless the ball rebounds off the goal-posts/crossbar.

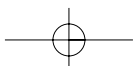

4.23 To make a divot for the purpose of teeing up the ball for a free kick or kick-out.

4.24 To advance the ball deliberately from the place at which a free kick or side-line kick is to be taken.

4.25 To waste time by delaying the taking of a free kick or side-line kick awarded to own team.

PENALTY FOR THE ABOVE FOULS -

(i) Cancel free kick or side-line kick.

(ii) Throw in the ball where the foul occurred except as provided under EXCEPTION (v) of Rule 2.2.

4.26 For a player taking the kick-out to take the ball into his hand(s) before another player has played it.

4.27 To be inside own 20m line when one's team is taking a kickout, except as provided in Rule 2.7.

4.28 For another player on the team taking the kick-out after a wide to play the ball before it has travelled 13m.

4.29 For a player on the team taking the kick-out after a score, other than the player taking the kick, to be less than 13m from the ball when it is kicked.

4.30 To waste time by delaying own kick-out.

4.31 To take the kick-out after a wide from outside the small rectangle.

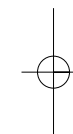

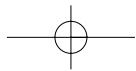

4.32 To take the kick-out after a score from outside the 20m line.

PENALTY FOR THE ABOVE FOULS -

- (i) Cancel kick-out.**
- (ii) Throw in the ball on defenders' 20m line in front of scoring space.**

4.33 For a player(s) from each team to foul simultaneously.

PENALTY - Throw in the ball where the fouls occurred except as provided in EXCEPTION (v) of Rule 2.2.

4.34 To go outside the boundary lines to gain an advantage except as provided in Rule 1.9:

4.35 To interfere with goal-posts to distract opponents or to gain an advantage.

PENALTY FOR THE ABOVE FOULS - Caution offender; order off for second cautionable foul.

4.36 When a team commits a technical foul, the referee may allow the play to continue if he considers it to be the advantage of the opposing team. Once he allows play to continue, he may not subsequently award a free for that foul. He shall apply any relevant disciplinary action.

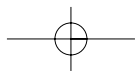
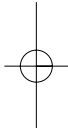

RULE 5 - AGGRESSIVE FOULS

5.1 To strike or attempt to strike an opponent with the head, arm, elbow, hand or knee.

5.2 To kick or attempt to kick an opponent.

5.3 To stamp on an opponent.

5.4 To behave in any manner which is dangerous to an opponent.

5.5 To strike or attempt to strike any match official. To interfere with or use abusive language or conduct to a match official.

PENALTY FOR THE ABOVE FOULS -

- (i) Order offender off.**
- (ii) Free kick from where the foul occurred except as provided under EXCEPTIONS of Rule 2.2.**

5.6 To commit any of the fouls listed in Rule 5.1 to Rule 5.4 inclusive against a team mate.

PENALTY -

- (i) Order offender off.**
- (ii) Throw in the ball where the foul occurred except as provided under EXCEPTION (v) of Rule 2.2.**

5.7 To commit any of the fouls listed under Rule 5.1 to Rule 5.4 inclusive on an opponent on the field prior to the start of the game or at half-time.

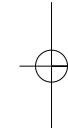

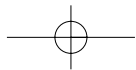

PENALTY - Offender shall be treated as ordered off and shall not participate (or further participate) in the game.

NOTE - Once the referee has received the list of players, or a substitution/temporary replacement slip which includes the offender's name, the player may not be substituted.

- 5.8 To pull down an opponent.
 - 5.9 To trip an opponent with hand(s) or foot.
 - 5.10 To jump at an opponent.
 - 5.11 To threaten or to use abusive or provocative language or gestures to an opponent.
 - 5.12 To block or attempt to block with the boot when an opponent is kicking the ball from the hand(s).
 - 5.13 To prevent or attempt to prevent an opponent from lifting or kicking the ball off the ground by striking an opponent's hand, arm, foot or leg with the boot.
 - 5.14 To engage in any other form of rough play.
- PENALTY FOR THE ABOVE FOULS -**
- (i) Caution the offender; order off for second cautionable foul.**
 - (ii) Free kick from where the foul occurred except as provided under EXCEPTIONS of Rule 2.2.**
- 5.15 To threaten or to use abusive or provocative language or gestures to a team-mate.

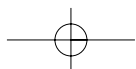

PENALTY -

- (i) Caution offender for second cautionable foul.**
- (ii) Throw in from where the foul occurred except as provided under EXCEPTION (v) of Rule 2.2.**

- 5.16 To push an opponent or hold an opponent with the hand(s).
- 5.17 To use the fist on or around the body of an opponent for the purpose of dispossessing him of the ball.
- 5.18 (a) To charge an opponent in the back or to the front.
- (b) To charge an opponent unless:-
 - (i) he is in possession of the ball, or
 - (ii) he is playing the ball, or
 - (iii) both players are moving in the direction of the ball to play it.
- (c) To charge an opponent for the purpose of giving an advantage to a team-mate.
- (d) To charge the goalkeeper in his small rectangle.
- (e) For a player in possession of the ball to charge an opponent.

PENALTY FOR THE ABOVE FOULS -

- (i) Free kick from where the foul occurred except as provided under EXCEPTIONS of Rule 2.2**

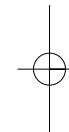

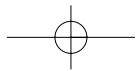

(ii) Caution offender for committing any of above fouls a second time. Order off for a further repetition or for other cautionable foul.

5.19 For a player to retaliate between the award of a free kick to his team and the free kick being taken.

PENALTY -

(i) Cancel free kick.

(ii) Throw in the ball where the original foul occurred except as provided under EXCEPTION (v) of Rule 2.2

(iii) Apply any other relevant penalty of Rule 5.

5.20 For a player(s) from each team to foul simultaneously.

PENALTY -

(i) Throw in the ball where the fouls occurred except as provided under EXCEPTION (v) of Rule 2.2.

(ii) Apply any other relevant penalty of Rule 5.

5.21 When an Aggressive Foul is drawn to the referee's attention by an umpire or linesman, the referee may apply the appropriate penalty, as per Rule 5, and shall restart play as per Rule 2.

5.22 When a team commits an aggressive foul, the referee may allow play to continue if he considers it to be to the advantage of the

offended team. Once he allows play to continue, he may not subsequently award a free for that foul. He shall apply the relevant penalty.

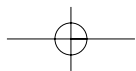

RULE 6 - DISSENT

6.1 To challenge the authority of a match official.
PENALTY - Caution the offender; order off for second cautionable foul.

6.2 To show dissent with the referee's to award a free kick to the opposing team.

PENALTY - The free kick already awarded shall be taken 13m more advantageous than the place of original kick - up to opponents' 13m line.

6.3 (a) To refuse to leave the field of play when ordered off.

(b) To rejoin the game after being ordered off.

PROCEDURE

First give a three minute warning to the team captain, or the official in charge of the team, or the player(s) involved, and then, if the player(s) refuses to comply, terminate the game.

6.4 A team or player(s) leaving the field without the referee's permission or refusing to continue playing.

PROCEDURE - AS IN RULE 6.3

Any player willing to continue shall give his name to the referee.

Important Terms and Definitions - Football and Hurling

The following list of Definitions of Terms used in the Playing Rules forms an integral part of these rules.

- | | |
|-----------------------|--|
| 1. BOUNCE | For a player to play the ball against the ground with his hand(s) and back to his hand(s) again. |
| 2. CATCH | To gain control of the ball with the hand(s) in a way which prevents it falling to the ground. |
| 3. CAUTION | To take a player's name and show him a yellow card. |
| 4. CHARGE (Fair) | Provided he has at least one foot on the ground, a player may make a side-to-side charge on an opponent (a) who is in possession of the ball, or (b) who is playing the ball or (c) both players are moving in the direction of the ball to play it. |
| 5. DELAY (Deliberate) | Deliberately taking too much time to retrieve the ball, or to restart play, or any action which unduly delays the restart of play. |

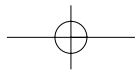

- 6. DIVOT An elevation formed from the surface of the pitch for the purpose of teeing up the ball on the ground.
- 7. HANDPASS When in possession, the ball may be struck with the open hand or fist - provided there is a definite striking action, with the striking hand not being in contact with ball before delivering the strike.
In a two-handed pass, the ball may be struck off a holding hand by the other hand, or released and struck. In a one-handed pass, the ball shall be released from the hand before being struck by the same hand. The releasing of the ball, when used, shall be considered an integral part of the hand/fisted pass.
- 8. FOUL
 - Aggressive To physically or verbally abuse any player or official.
 - Dissent To disagree openly with any official about any decision.
 - Technical To 'foul' the ball, or any other foul that is not aggressive or dissenting.

- 9. IN FLIGHT The ball is deemed to be in flight, once it is off the ground, having been played away within the Rules of Fair Play.
- 10. LIFT To use the foot or feet to raise the ball from the ground to the hand(s).
- 11. OVERCARRY To take more than four steps while holding the ball in the hand(s).
- 12. OVERHOLD To hold the ball longer than is required to take four steps.
- 13. PLAY THE BALL To touch the ball. The last player touching the ball before it crosses a boundary line shall be considered the last person playing it.
- 14. 'PULL' (FAIR) To swing the hurley to play or attempt to play the ball.
- 15. TACKLE Any attempt to dispossess or reduce the advantage of opponent within the Rules of Fair Play. With the exception of the charge (fair), the tackle is aimed at the ball not the player.
- 16. THROW When the ball, held in the hand(s), is played away without a definite striking action.

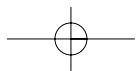
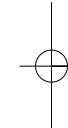
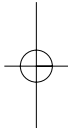



- 17. THROW-IN
To throw the ball up over the heads of one player from each team (Football), or to throw the ball along the ground between one player from each team (Hurling). For the start of the game and the restart after half-time, the throw-in shall be between two players from each team.

- 18. TOE-TAP
To release the ball from the hand(s) to the foot and kick it back into the hand(s).

- 19. TOSS
To release the ball from the hand(s) to kick it, toe-tap it, or pass it with the hand(s).
(Football)
(Hurling)

- 20. WREST
To attempt to dispossess an opponent who already has a (firm) hold on the ball, by grabbing the ball to take it from him.

Index

(Note: References in this Index are to Rule-numbers, NOT page-numbers, except where page-numbers are given.)

PART I Rules of Specification & Control (pages 5 to 22)

- A**
- Arc the 1.5

- B**
- Blood Rule, 1.5 pages 17, 18, 19
- Boundary lines: see Field of Play

- C**
- Colours
 - club 4.1 (i)
 - county 4.1 (ii)
 - goalkeeper's jersey 4.1 (iii)
- Control of games 1
- Crossbar: see Field of Play

- D**
- Definitions: pages 69 - 72
- Dissent: see pages 44, 68

- E**
- Equipment 4
 - club colours 4.1 (i)
 - county colours 4.1 (ii)
 - exceptions 4.3
 - football, weight/dimensions 4.3 (ii)
 - goalkeeper's jersey, colour 4.1 (ii)
 - hurling ball, weight/dimensions 4.3 (i)
- Endlines: see Field of Play



Extra Time: see Time

Field of Play 1

- boundary lines 1.2 (i)
- crossbar, location/dimensions 1.3 (ii)
- dimensions 1.1
- endlines 1.2 (i)
- exceptions (to dimensions) 1.1, 1.3
- flags 1.2 (i), 1.7
- goalnets (locations, support, mesh) 1.3 (iii)
- goalposts (height, space between) 1.3 (i)
- lines (width & marking) 1.2 (ii)
- midline 1.2 (i)
- scoring space
 - location, formation 1.3 (i)
 - rectangles 1.4
- shape 1.1
- Flags: see Field of Play
- Football 4.3 (ii)

G

- Goalkeeper, jersey colour 4.1 (iii)
- Goalnets: see Field of Play
- Goalposts: see Field of Play
- Goal Umpires: see Umpires

H

- Half-time intervals, see Time
- Helmet, prohibited for football 4.2
- Hurley, width of bas 4.4
- Hurling ball 4.3 (i)

L

- Lines: see Field of Play
- Linesmen
 - powers 3.1
 - duties 3.2

List of Players: see Players

M

Midline: see Field of Play

P

Players 2

- exception 2.1
- late arrivals 2.3
- list of players
- general rules 2.5 (i)
- inter-county games 2.5 (ii)
- substitutions 2.4
- team
 - of 13, when permitted 2.2
 - of 15 2.1

Temporary Replacement Players: See Blood Rule

Playing time: see Time

R

Referee

- commencing play 1.3 (page 17)
- duties 1.2 (pages 14, 15, 16)
- hurling helmet 4.2 (page 11)
- injuries/incursions 1.4 (page 17)
- list of players 1.2, 2.5 (pages 14 & 8)
- powers 1.1 (pages 13, 14)
- report of game 1.6 (pages 19, 20)
- substitutions 2.4 (page 8)

See also Parts II & III of Index

Rules of Control (pages 13 to 22)

Rules of Specification (pages 5 to 12)

S

- Scoring space: see Field of Play
- Slíotar: see Hurling Ball
- Substitutions: see Players
- Substitution Zone - 1.6 (page 7)

T





Team: see Players
 Temporary Replacement Players: See Blood Rule
 Time 3 (pages 9, 10 & 11)
 exceptions 3.2 (i), 3.2 (ii) (pages 10 & 11)
 extra time 3.1, 3.4, 3.5 (pages, 9, 10 & 11)
 half-time interval 3.3 (page 10)
 playing time 3.2 (pages 9 & 10)
 taking the field 3.1 (page 9)

U

Umpires 2 (pages 20 & 21)
 duties 2.2 (pages 20, 21)
 location 2 (page 20)
 powers 2.1 (page 20)
 signalling of decisions 2.2 (pages 20, 21)

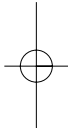

PART 2

Playing Rules of Hurling

(pages 23 to 44)

A

Abusive/threatening language/gestures to opponent, etc. 5.11, 5.17
 Advantage Rule 4.34, 5.25
 Aggressive Fouls 5
 Arc the 2.3, 4.11 (c)
 At half-time (and prior to start), commission of certain aggressive fouls 5.7 (page 39)

B

Ball

advancing from where free, etc. to be taken 4.25
 attempting to lift (side-line puck) 4.23
 balanced/hopping on hurley 1.3
 carried in hand 1.4
 carrying over opponents' line 4.12
 catching before playing 4.6
 in play (defined) 1.1
 lifting with knees 4.3
 lying on 4.4
 making divot for 4.24
 overcarrying/overholding 4.1
 played from hurley to hand 1.4
 played over side-line 2.8
 playing again after free/side-line puck, etc. 4.21
 playing before travels 13m 4.29
 resetting for free puck without permission after whistle 4.20
 standing/moving too near when own team awarded
 free/side-line puck 4.11
 standing/moving too near when opponents awarded
 free/side-line puck 4.17
 striking, generally 1.5

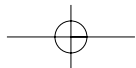
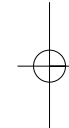

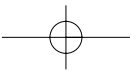

striking for free/penalty puck 2.5
 struck with hurley (when, defined) 1.2
 tackling opponent for 1.8
 taking into hand second time before striking puck-out 4.27
 throwing 4.2
 tossing with hand, etc. 4.7
 touched on ground with hand 1.6
 touching non-player 1.5
 touching on grounds with hands (& exceptions) 4.5

Behaviour dangerous to opponent 5.4
 Boundary lines, going outside (& exceptions) 4.32

C

Challenge to match official's authority (& penalty) 6.1
 Charging opponent 5.19
 Commission of certain fouls
 against team-mate 5.6
 against opponent (start/half-time) 5.7

D

Defender too close to penalty puck 4.16
 Definitions: see pages 69 to 72
 Delaying opponent taking free/side-line puck 4.18
 Dissent 6
 Dissent with decision to award free puck (&penalty) 6.2
 Divoting making forbidden 4.24

F

Fair Play 1 - 3
 Field of Play, when permitted to go outside 1.10
 see also Part I of Index
 Foul Play 4 - 6
 Free Puck
 after ball over side-line 2.8
 delaying opponent 4.18
 fouling (second attempt) 4.22
 how ball is struck 2.5
 interception of 1.1

interference with taking of 4.19
 opposing player too close 4.17

G

Goal, when scored 3.1
 Goalkeeper
 challenge of 1.9
 jersey colour: see Part I of Index
 Goalposts, interference with 4.33

H

Hurley
 bas, width of: see Part I of Index
 dropping 4.8
 striking opponents' hurley 5.21
 tipping of opponent's hurley 4.9
 Throwing 4.8
 use of, in certain foul play 5.13, 5.16, 5.18, 5.20

I

Inside 20m line before puck-out taken 4.14, 4.28
 Interference with player taking free/side-line puck
 (& exceptions) 4.19

J

Jumping at opponent: see Pulling Down, etc.

K

Kicking/attempting to kick opponent 5.2

L

Leaving field without referee's permission: see Referee

M

Match officials' authority (challenge): see Challenge

P

Penalties 2.3, 2.5
 Penalties for aggressive foul - after 5.5, 5.6, 5.7, 5.16, 5.17, 5.21,
 5.22, 5.23

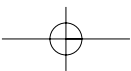



Penalties for technical fouls- after 4.13, 4.14, 4.15, 4.16, 4.17,
4.19, 4.26, 4.30, 4.31
Penalty puck (generally) 2.2, 2.3
defender too close 4.16 (b)
Play 1
Point, when scored 3.1
Puck-out:
after score orwide 2.5
being inside opponents' 20m line before taken 4.14
being inside own 20m line before taken 4.28
delaying 4.30
taking ball into hand a second time 4.27
taking from outside small rectangle 4.15
to play ball before it has travelled 13m (by defender) 4.29

R

Referee
advantage rule 4.34, 5.25
application of penalty, etc. when aggressive foul drawn to
attention by umpire/linesman 5.24
procedure on player's leaving field without permission 6.4
procedure on player's refusal to leave field 6.3
starting/restarting game 2.1, 2.2
Refusal to leave field when ordered (& procedure for referee) 6.3
Refusal to continue playing (& procedure for referee) 6.4
Restart of game, after 'wide' or score 2.6
see also Starting
Retaliation between award of free & free puck 5.22
Rough play (any form) 5.12
Rules of Hurling: pages 23 to 44

S

Score, when allowable 3.2 to 3.4
Scores 3
Scoring with hands when in possession of ball 4.13
Set Play 2
Side-to-side charge 1.9
Simultaneous fouls by opposing players 2.4, 4.31, 5.23

Small rectangle
taking puck from outside 4.15
when entry allowed/forbidden 4.10
Stamping on opponent 5.3
Starting/restarting game (& exceptions) 2.1, 2.2
Striking/attempting to strike opponent (with arm, elbow, hand,
head, hurley, knee) 5.1
Striking (inc. attempt), interference, threat or use of abusive
language/conduct to match officials 5.5
Striking opponent's hurley unless both in act of striking ball 5.21

T

Team-mate, fouls, against 5.6
Technical Fouls 4
Tripping opponents: see Pulling-down, etc.

U

Use of hurley in specified foul play 5.13 5.16, 5.18, 5.20

W

Wasting time (free or side-line puck) 4.26.



PART 3

Playing Rules of Gaelic Football

(pages 45 to 68)

A

Abusive/threatening language/gestures to opponent, etc 5.11, 5.15
 Advantage Rule 4.36, 5.22
 Aggressive Fouls
 against team-mate 5.6
 at half-time (and prior to start) 5.7
 generally 5
 Arc the 2.3, 4.11 (b) 4.16 (a)

B

Ball
 advancing from where free/side-line kick, to be taken 4.24
 bounced 1.4 (C), 1.5
 bouncing more than once after catching 4.6
 carried/held in hand(s) 1.4 (a)
 carrying over opponents' line 3.1
 catching after playing 4.7
 changing from hand to hand 1.4 (d)
 changing from one hand to other 4.10
 fisted/palmed on ground 1.2 (ii)
 handpassing without definite striking action 4.2 (b)
 in play (defined) 1.1
 knocked from opponent's hands 1.4
 lifting with knees 1.2 (iii). 4.3
 making divot for 4.23
 not on ground, how playable 1.3
 on ground, how playable 1.3
 overcarrying/overholding 4.1
 palmed; see fisted
 played from foot to hand 1.4 (b)

played over end-line by defender (45m free) 2.8
 played over boundary line 1.1 (b)
 played over end-line by attacking team 2.7 (a)
 played over side-line 2.9
 playing again after free kick/penalty/side-line kick 4.22
 playing before travels 13m 4.29
 possessed by player, how playable 1.4
 resetting for free kick/penalty/kick-out without
 permission after whistle 4.21
 scoring permitted if struck in flight with hand(s) 3.1
 standing/moving too near when own team awarded
 free/side-line kick 4.11(a)
 standing/moving too near when opponents awarded
 free/side-line kick 4.17
 striking flag 1.1 (b)
 struck with open hand(s)/fist 1.4 (e)
 throwing 4.2 (a)
 toe-tapped 1.4 (b), 1.4 (c)
 tossed 1.4 (f)
 touched on ground with hand 4.5
 touching non-player 1.1 (c), 2.10
 touching on ground with hand(s) 4.5
 wrestling from opponent 4.8
 Behaviour dangerous to opponent 5.4
 Bounce (defined) page 69
 Blocking with boot 5.12
 Boundary lines, going outside 1.9, 4.34

C

Catch (defined) page 69
 Caution (defined) page 69
 Challenge to match official's authority (& penalty) 6.1
 Charge (defined) page 69
 Charging opponent 5.18
 Commission of certain fouls
 against team-mate 5.6

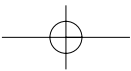

against opponent (start/half-time) 5.7
 Cross-bar displaced 3.3 (b)

D

Defender too close to penalty kick 4.16
 Definitions: see pages 69 to 72
 Delay (defined) page 69
 Delaying opponent taking free/side-line kick 4.18
 Dissent
 generally 6
 with decision to award free kick (& penalty) 6.2
 Divot (defined) page 70
 Divot-making forbidden 4.23

F

Fair Play 1 - 3
 Field of Play: see Part I of Index
 Foul
 by defender within rectangle 2.2
 (defined) page 70
 by defender within 13m line 2.2
 on player after ball played and score resulting 2.2
 Foul Play 4 - 6
 Free kick 2.5
 after ball over end-line by defending team 2.8
 after ball over-side-line 2.9
 delaying opponent 4.18
 how to kick 2.5
 immediate taking, with referee's consent 2.6
 interception of 1.10
 interference with taking of 4.19

G

Goalkeeper
 challenge of 1.7

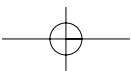

incidental contact with 1.7
 jersey colour: see Part I of Index
 moving along goal-line while penalty being taken 1.8
 playing ball on ground with hands 1.2 (i)

H

Handpass (defined) page 70

I

Interference with player taking free/side-line kick 4.19

J

Jumping at opponent: see Pulling down, etc.

K

Kicking/attempting to kick opponent 5.2
 Kick-out
 after score 2.7 (b)
 being inside opponents' 20m line before taken 4.14
 being inside own 20m line at taking of 4.27
 being less than 13m from ball for certain frees 4.15
 being less than 13m from ball before kick 4.20, 4.29
 delaying 4.30
 taking ball into hands 4.25
 taking of after score from outside 20m line 4.32
 taking from outside small rectangle after wide 4.31
 to play ball before it has travelled 13m (by defender) 4.29

L

Leaving field without referee's permission: see Referee
 Lift (defined) page 71

M

Match officials' authority (challenge to): see Challenge

O

Options to player fouled 2.5
 Overcarry (defined) page 71
 Overhold (defined) page 71
 "Own score" allowable 3.4

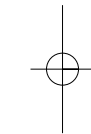

P

Penalty kick
 defender/goalkeeper too close 4.16 (a) & (b)
 generally 2.3
 Penalties for aggressive fouls - after 5.5, 5.6, 5.7, 5.14, 5.15, 5.18, 5.19, 5.20
 Penalties for technical fouls - after 4.13, 4.14, 4.15, 4.16, 4.17, 4.19, 4.20, 4.25, 4.32, 4.33, 4.35
 Play 1
 Play (of ball) (defined) page 71
 Point, when scored 3.1
 Preventing opponent from lifting/kicking ball 5.13
 Pull (defined) page 71
 Pulling down opponent 5.8
 Pushing/holding opponent with hand(s) 5.16

R

Referee
 Advantage rule 4.36, 5.22
 application of penalty etc. when aggressive foul drawn to attention by umpire/linesman 5.21
 consent to immediate taking of free kick 2.6
 procedure on player's leaving field without permission 6.4
 procedure on player's refusal to leave field 6.3
 signalling play to stop 1.1 (a)
 starting/restarting game 2.1, 2.2
 Refusal to leave field when ordered (& procedure for referee) 6.3 (a)
 Refusal to continue playing (& procedure for referee) 6.4
 Rejoining game after ordered off 6.3 (b)
 Restart of game
 see Starting
 when ball played over end-line by attacking team 2.7 (a)
 Retaliation between award of free and free kick 5.19
 Rough play (any form) 5.14

S

Score, when allowable 3.2, 3.3, 3.4
 Scores 3
 Scoring when in possession of ball 4.12, 4.13
 Set Play 2
 Side-to-side charge 1.7
 Simultaneous fouls by opposing players 2.4, 4.33, 5.20
 Small rectangle
 charging/challenging goalkeeper in 1.7
 when entry allowed/forbidden 4.9
 Tackle (defined) page 71
 Tackling opponent for ball 1.6
 Team-mate, fouls against 5.6
 Technical fouls 4
 Throw (defined) page 71
 Throw-in (defined) page 72
 where given between end-and 20m lines 2.2
 Top-tap (defined) page 72
 Toss (defined) page 72
 Tripping opponent: see Pulling-down, etc.

W

Wasting time (free/side-line kick) 4.25, 4.30
 Wrest (defined) page 72

